



0340



---

# Asbestos Survey Report

## Management Survey (With Priority Assessments)

1 SINCLAIR PLACE  
EDINBURGH  
EH11 1AN

Project Number: S-61210  
Issue Date: 9 January 2017  
Issue No: 1



### **DUNEDIN CANMOREGROUP**

DUNEDIN CANMOREGROUP

CLAIRE DOW

8 NEW MART ROAD

EDINBURGH

EH14 1RL

### **Life Environmental Services Ltd**

4 Duckett's Wharf

South Street

Bishop's Stortford

Hertfordshire

CM23 3AR

Tel:

Tel: 01279 503117

# Life Environmental - Survey Report Guide

---

This guide explains the Section content of the survey report. Failure to use the information provided in the report correctly may result in incorrect information or assumptions being obtained.

## Section 1.0 Executive Summary

The Executive Summary contains details of the scope and extent of the works. The reader must ensure that the scope covers the required areas and that any variations do not impact on any proposed works or management of the site. **All areas of no access should be considered as containing asbestos until proven otherwise.**

Recommended Actions provides a summary of all identified and presumed asbestos containing materials (ACMs). ACMs are listed by recommendation with those requiring urgent attention listed first.

The Asbestos Register presents ACMs by building, floor & location. It provides a detailed list of all locations included within the survey where positive samples have been taken or items are presumed to contain asbestos. Items physically sampled will show the asbestos type within the analysis column.

Items cross referenced (strong presumption) have their asbestos type determined by the sample result of materials of similar appearance and use that have been sampled elsewhere on site. These will show the analysis preceded by X.

Strongly Presumed samples are items that the surveyor was unable to sample but the materials are similar in appearance and use to known asbestos-containing materials and hence they are confirmed as containing asbestos.

Presumed items are those that the surveyor was unable to sample or inspect adequately to confirm the presence of asbestos, as such there is a potential for asbestos being present and the item is presumed to contain asbestos.

A Material Assessment algorithm has been completed for all positive samples. It should be noted that to enable an accurate Priority Assessment to be undertaken this requires a detailed knowledge of the property. The responsibility for this lies with the dutyholder, although Life Environmental can assist with the provision of information or generic assessments where agreed.

Recommendations within this report are based on the condition of the asbestos and the Material Assessment. Prior to carrying out these recommendations consideration should be given to the Priority Assessment Algorithm.

## Section 2.0 Introduction

The Introduction provides a general overview of the purpose, aims and type of survey undertaken. It also presents Project particulars and Quality Assurance.

## Section 3.0 Methodology & Limitations of Method

This section details the survey methodology adopted and the specific scope of the survey works agreed with the client. Within Management Surveys access will generally not involve any intrusive investigations unless agreed with the client. The specific limitations for the survey are detailed within the table. Should any variations occur against the agreed scope then details of these will be given within the table. These will be agreed with the client at the time of the survey.

## Section 4.0 Survey Findings – Survey Data Sheets

Survey Data Sheets contains detailed information on all suspect items with a photographic record of each item.

## Section 5.0 Survey Findings – Location Register

Location Register summarises location by location all identified and presumed asbestos, all areas of no access and limited access, and all recorded non-asbestos materials

## Section 6.0 – Survey Findings – Certificate & Schedule of Bulk Samples

This section provides analysis information and results of all samples taken.

## Appendices 1 & 2 - Definitions & Recommended Guidance & Material & Priority Assessment algorithms

These contain a general guidance relating to Samples, Assessments and Recommendations and a detailed Risk Assessment explanation.

## Appendix 3 - Survey Drawings

## Life Environmental - Survey Report Guide

---

All locations will be given a unique reference number which corresponds to the location detailed within the Asbestos Register. The drawings highlight areas containing positive information and areas of no access. In the case of planned works, a check should always be made of adjacent areas.

# Table of Contents

---

## **1.0 Executive Summary**

- 1.1 Scope of Works
- 1.2 Recommended Actions
- 1.3 Asbestos Register

## **2.0 Introduction**

- 2.1 Purpose & Aim of Survey
- 2.2 Type of survey – Management Survey
- 2.3 Project Particulars
- 2.4 Quality Assurance

## **3.0 Methodology & Limitations of Method**

- 3.1 Scoping Table

## **4.0 Survey Findings – Survey Data Sheets**

## **5.0 Survey Findings – Location Register**

## **6.0 Survey Findings – Certificate & Schedule of Bulk Samples**

### **Appendices**

- Appendix 1 - Definitions & Recommended Guidance
- Appendix 2 - Material & Priority Assessment algorithms
- Appendix 3 - Survey Drawings

## 1.0 Executive Summary

---

The brief for these works was to carry out a Management Survey (as defined in HSG 264) for the presence of asbestos containing materials within the locations as identified below:

### 1.1 Scope of Works:

Management survey to be carried out to the premise.

The scope of the survey should be noted in conjunction with all agreed exclusions and any additional access limitations. Additional limitations may affect the validity of this report and additional works may be required in order to ensure the report is fit for purpose.

### 1.2 Recommended Actions

Below is a summary of all identified and presumed asbestos and guidance on necessary actions which should be taken to prevent potential exposure to Asbestos Containing Materials (ACMs).

The recommendations provided are based primarily on reducing the Material Assessment parameters, e.g. through encapsulation or removal. When deciding on prioritisation and the required action, full consideration should also be given to controlling the Priority Assessment parameters, e.g. through restricting access etc.

Please contact Life Environmental Services Ltd for advice in dealing with any asbestos in poor, unsealed or damaged condition or for assistance in developing your Management Plan, and scheduling re-inspections.

All locations were accessible at the time of this survey.

## 1.3 Asbestos Register

---

ACMs were not identified or presumed during the survey. Please note, some items may be detailed under Floor 'Multiple' if the room is present over multiple floors.

## 2.0 Introduction

---

### 2.1 Purpose and Aim of survey

The purpose of this Management Survey is to help the duty holder manage asbestos in these premises. It provides sufficient information for an asbestos register to be generated in accordance with HSG 264 so that the duty holder can carry out a Risk Assessment and prepare a suitable Management Plan in accordance with Reg 4 of the Control of Asbestos Regulations 2012 (CAR 2012).

The aim of a Management Survey is to:

1. Locate and record the location, extent, and product type as far as reasonably practicable of known or presumed ACMs
2. Inspect and record information on the accessibility, condition and surface treatment of known or presumed ACMs
3. Determine and record the asbestos type based on sampling or by making a presumption based on product type and appearance

### 2.2 Type of survey – Management Survey with Priority Assessments

This Management Survey is required for the normal occupation and use of the building to ensure continued management of any ACMs in situ.

Its purpose is to locate as far as is reasonably practicable, the presence and extent of any suspect ACMs in the building which could be damaged or disturbed during normal occupancy, including foreseeable maintenance and installation and to assess their condition

All areas have been accessed as far as is reasonably practicable. Any areas that it was not possible to access have been presumed to contain asbestos and documented within this report.

Management Surveys will involve minor intrusive work and some disturbance. The extent of the intrusion will vary between premises and depend on what is reasonably practicable for individual properties e.g. type of building, nature of construction, etc.

Generally if inspection of an area is possible via a hatch or moveable panel this will be included within the remit of a Management Survey. Inspection of areas that would require dismantling of fixtures and fittings or damage to such items does not fall within the remit of a Management Survey.

This Management Survey includes a material assessment and a priority assessment of the identified or presumed ACM's, these assessments are explained in the following sections of this report. The assessments will provide the duty holder with a guide to the priority for managing ACM's as they will identify those ACM's which will most readily release fibres if they are disturbed and also those materials that are most likely to come into contact with persons occupying the building.

This survey involved sampling and analysis to confirm the presence or absence of asbestos; however presumptions may also have been used within this report to presume the presence of ACMs.

It is recommended that further intrusive inspection and sampling be carried out where site refurbishment, maintenance, or similar may disturb ACMs that have remained inaccessible during this survey; this should be a Refurbishment/Demolition Survey as described in HSG 264.

*In order for a building occupier to meet their duties under Reg 4 of the Control of Asbestos Regulations 2012 they must implement a Management Plan for known or presumed ACMs. This Survey Report can be used as a basis to start developing a Management Plan and prioritise actions but in itself does not constitute a Management Plan as required under the Control of Asbestos Regulations 2012. Further guidance on the implementation of asbestos Management Plans can be found in the HSE Guidance documents HSG 227 "A Comprehensive Guide to Managing Asbestos in Premises".*

## 2.0 Introduction

### 2.3 Project Particulars

Life Environmental Services Ltd received an order of confirmation to undertake a Management Survey from DUNEDIN CANMOREGROUP. This order has been accepted on the basis of the original Quotation and Survey Plan and our terms and conditions of business.

All subsequent information provided by the client or ascertained otherwise was assessed during planning stage of the project and a suitable Plan of Work produced. Where information was provided regarding the presence of known or presumed asbestos materials then this has been validated during the course of the survey, and recorded within this report.

This survey was carried out in accordance with documented in house procedures and HSE Guidance document HSG 264.

#### Scope of Works:

Management survey to be carried out to the premise.

**Site Description:** Mid 1900s. Brick construction. Block of flats. Pitched tied roof.

### 1.4 Quality Assurance

<b>Client Details:</b>	DUNEDIN CANMOREGROUP	
<b>Date(s) of Survey:</b>	19-December-2016	
<b>Surveyor(s):</b>	Lead Surveyor(s): William Stevenson Assistant Surveyor(s): N/A	
<b>Report Prepared by:</b>	Linda McLintock	9 January 2017
<b>Quality Control by:</b>	Linda McLintock	9 January 2017
<b>Technical Review:</b>	William Stevenson	9 January 2017
<b>Life Environmental Project Manager:</b>	Mandy Meechan	



### 3.0 Methodology & Limitations of Method

---

For safety reasons it is not possible to inspect internal areas of live electrical items, heating, ventilation, or mechanical plant and machinery.

Whilst all areas of the building included within the scope of the survey will be accessed and inspected as far as reasonably practicable, Life Environmental Services Ltd cannot be held responsible for asbestos potentially present in areas of the building not explicitly specified within the client instruction, not indicated on provided site plans or not physically possible to access.

Although every care has been taken to identify all asbestos containing products within the areas surveyed, this survey does not include those areas where obtaining a sample would cause undue damage to the integrity and security of the building, risk the safety of our operatives or where access could not be gained. Asbestos should be presumed to be present within any areas not surveyed until a further assessment can be carried out.

It is important to note that the degree of inspection performed during an asbestos survey is not as detailed as the inspections and analytical processes carried out following the removal of ACMs. Visual inspections during clearance procedures involve a detailed examination of all areas and surfaces within an asbestos enclosure and although a survey should identify ACMs within an area where inadequate asbestos removal activities have been previously undertaken, it is not designed to check on the effectiveness of such inspections. Where previous asbestos removal work has taken place, reference should also be made to clearance documentation when reading this report.

The survey includes taking dust samples from areas where contamination is suspected to be present due to visible signs of damage to asbestos or signs of previous asbestos removal works but does not include random dust sampling.

Where suspect materials are identified as part of any works that do not appear to be detailed within the survey report then these materials should be treated with caution and presumed to contain asbestos until sampled and analysed.

Decorative coatings and paints etc. (such as "Artex") may contain a trace quantity of Chrysotile asbestos. Due to this low asbestos content, applications of this product may be non-homogenous and may elicit both positive and negative sample results. Where both positive and negative samples are obtained the client should presume that the textured coatings contain Chrysotile throughout even though a non-detected result has been obtained. It should also be noted that asbestos may exist in paint with no obvious textured appearance. Random sampling of such paint is not carried out routinely unless specifically requested.

Due to the non-homogenous nature of some thermal insulation products it is possible to obtain both a positive and negative result when sampling the same material. In instances where this occurs then all sample results for the given insulation type should be treated as containing asbestos. This applies to all thermal insulation and insulation residues and debris.

Materials have been referred to as Asbestos Insulating Board or Asbestos Cement based upon their appearance alone. Water absorption testing, as detailed within L143, has not been carried out unless stated otherwise.

Where asbestos gaskets to pipe flanges have been identified it is not practical to trace these throughout the length of pipework within the property. All such gaskets are presumed to contain asbestos.

Unless specifically identified within the report, no responsibility can be accepted for stored or portable items of asbestos.

Whilst all asbestos materials have been identified as far as is reasonably practicable, some asbestos materials may remain unidentified within the fabric of the building. This includes ACMs concealed by suspect items.

Unless specifically identified within the report, no responsibility can be accepted for non-systematic or random use of asbestos within the property. It must be presumed that asbestos may remain unidentified to these types of areas and if suspect materials are uncovered then samples should be taken for analysis.

Material extents are approximations only, assigned by the surveyor at the time of the survey. It should be noted that such extents may be for specific, visible amounts of the asbestos item and not for the complete amount. As such, the stated extents should not be used as a basis of any Scope or Specifications of Works for that item. It is recommended that any proposed abatement/removal of the asbestos should be undertaken against a detailed specification, therefore Life Environmental Services Ltd cannot be held responsible for any misinterpretation of the contents of this report by a third party if they were not instructed to provide a specification.

This report does not include investigations into land contamination associated with asbestos or any other contaminant.

### 3.0 Methodology & Limitations of Method

---

Life Environmental Services Ltd makes every effort to locate and identify all Asbestos Containing Materials (ACMs), within the scope of the agreed inspection brief, supplied by the client. Due to the nature of Asbestos distribution and uncontrolled usage within buildings built prior to 1999, Life Environmental Services Ltd will not accept any liability for claims arising from post survey, hidden or unidentified ACMs, or contamination arising from their subsequent disturbance.

Due to Management Surveys being non-intrusive in their nature, asbestos may remain unidentified within common locations where non-intrusive inspection would not normally be possible, for example:

- As internal linings to fire doors and hatches
- As packing around door and window frames
- Within the fabric of the building including cavity walls, floor voids and foundations, etc
- Behind or within fixed wall linings, fixed boxings, fixed ceilings, etc
- Below fixed floor coverings
- Below existing felt and bitumen roof coverings
- Within drainage systems and below ground services
- Within chimneys and chimney breasts
- Residual asbestos material may be present beneath re-insulated services and cannot be detected unless the insulation is systematically removed. Caution should therefore be taken when working on such materials for the potential presence of asbestos residue

## 3.0 Methodology & Limitations of Method

### 3.3 Scoping Table

Management Survey - Access Allowances – The following access requirements have been agreed at Quotation Stage		
Intrusive access and other access provision - Based on agreed Scope	Areas included within Scope of survey	Surveyors Comment / Detail of any variation
<b>Height</b> access provision	Standard (3m) <input type="radio"/> Long (6m) <input checked="" type="radio"/> Tower (4m) <input type="radio"/> Tower (6-10m) <input type="radio"/> Power (10m+) <input type="radio"/> Standard, Tower <input type="radio"/> Standard, Tower, Power <input type="radio"/>	N/A
<b>Loftspaces</b> (Note: access for management surveys will only be made where safe and sufficient walkways are available)	Yes <input checked="" type="radio"/> No <input type="radio"/> Where no safe and accessible walkways are present inspections will be carried out from the hatch only.	N/A
<b>Electrical switchgear</b>	Yes <input type="radio"/> No <input checked="" type="radio"/> Record surface in non-asbestos list e.g. "Electrical Box - Metal"	N/A
<b>Plant / equipment</b>	Yes <input type="radio"/> No <input checked="" type="radio"/> Record surface in non-asbestos list e.g. "Boiler - Metal"	N/A
<b>Lift shafts</b>	Yes <input type="radio"/> No <input checked="" type="radio"/>	N/A
<b>Escalator Pits</b>	Yes <input type="radio"/> No <input checked="" type="radio"/>	N/A
<b>Confined spaces</b>	Yes <input type="radio"/> No <input checked="" type="radio"/>	N/A
<b>External soffits &amp; Fascias</b>	Yes <input type="radio"/> No <input checked="" type="radio"/> Where practicable	N/A
<b>Roof</b> (requiring specialist equipment)	Yes <input type="radio"/> No <input checked="" type="radio"/> Where practicable	N/A
<b>Boxing</b> (readily accessible by removable panels)	Yes <input checked="" type="radio"/> No <input type="radio"/> Within boxing`s will only be accessed where removable screws are present and allow access causing no damage. All other boxing will be recorded as `Fixed` to indicate that within the boxing void was not accessed.	N/A
<b>Solid Wall cavities</b>	Yes <input type="radio"/> No <input checked="" type="radio"/>	N/A

### 3.0 Methodology & Limitations of Method

Management Survey - Access Allowances – The following access requirements have been agreed at Quotation Stage		
Intrusive access and other access provision - Based on agreed Scope	Areas included within Scope of survey	Surveyors Comment / Detail of any variation
Partition Wall cavities	Yes <input type="radio"/> No <input checked="" type="radio"/>	N/A
Wall Cladding & Coverings	Yes <input type="radio"/> No <input checked="" type="radio"/>	N/A
Fixed suspended ceilings	Yes <input type="radio"/> No <input checked="" type="radio"/>	N/A
Glazing	Yes <input type="radio"/> No <input checked="" type="radio"/>	N/A
Window Frames	Yes <input type="radio"/> No <input checked="" type="radio"/>	N/A
Window sills	Yes <input type="radio"/> No <input checked="" type="radio"/>	N/A
Door Frames	Yes <input type="radio"/> No <input checked="" type="radio"/>	N/A
Doors internally	Yes <input type="radio"/> No <input checked="" type="radio"/>	N/A
Concealed Risers or Voids (Known or identified during survey)	Yes <input type="radio"/> No <input checked="" type="radio"/>	N/A
Ventilation trunking (fume trunking should be specifically identified and assessed)	Yes <input type="radio"/> No <input checked="" type="radio"/>	N/A
Skirting	Yes <input type="radio"/> No <input checked="" type="radio"/>	N/A
Fixed Flooring	Yes <input type="radio"/> No <input checked="" type="radio"/>	N/A
Floor voids	Yes <input type="radio"/> No <input checked="" type="radio"/>	N/A
Floor ducts (specific details / layout required; specialist lifting equipment; covered or known)	Yes <input type="radio"/> No <input checked="" type="radio"/>	N/A
Below Ground Drainage Systems	Yes <input type="radio"/> No <input checked="" type="radio"/>	N/A
Slab (specify depth / diameter)	Yes <input type="radio"/> No <input checked="" type="radio"/>	N/A
Locked Locations	Client / Site to provide access <input checked="" type="radio"/> Life to provide Locksmith <input type="radio"/> Life to force entry <input type="radio"/>	N/A

### 3.0 Methodology & Limitations of Method

Management Survey - Access Allowances – The following access requirements have been agreed at Quotation Stage		
Intrusive access and other access provision - Based on agreed Scope	Areas included within Scope of survey	Surveyors Comment / Detail of any variation
Beyond suspected or known asbestos installations	Yes <input type="radio"/> No <input checked="" type="radio"/>	N/A
Other Variations to Scope	N/A	

**Note: If any activities are to be undertaken within areas that have not been accessed as part of this survey then a further survey and assessment should be carried out prior to these works**

## 4.0 Survey Findings – Survey Data Sheets

Surveyor		William Stevenson		Room/Area		001 - Ground Floor Landing And Stairs			
Survey Date		19 December 2016		Level of Identification		Sampled			
				Sample No		0001			
Building		1 SINCLAIR PLACE		Item		Textured Coating To Plasterboard Ceiling			
Floor		0		Amount					
A - Product Type:		B - Extent of Damage:		C - Surface Treatment		D - Asbestos Type		Material Ass (M.A) (A+B+C+D):	
Textured Coating						No Asbestos Detected		0	
1 = Normal Occupant Activity = (E)		E - Main type of activity		Total Priority Score (P.A.) = (1+2+3+4):		Total Risk Ass' Score (P.A. + M.A)		0	
2 = Disturbance = (F+G+H)/3		F - Location		G - Accessibility		H - Extent		Risk Coding	
3 = Exposure potential = (I+J+K)/3		I - Number of occupants		J - Frequency of use		K - Average time in use			
4 = Maintenance activity = (L+M)/2		L - Type of maintenance		M - Frequency of maintenance		Recommendation:		No recommendation required	
Further Information:									

Surveyor		William Stevenson		Room/Area		006 - First Floor Landing And Stairs			
Survey Date		19 December 2016		Level of Identification		Sampled			
				Sample No		0002			
Building		1 SINCLAIR PLACE		Item		Textured Coating To Plasterboard Ceiling			
Floor		1		Amount					
A - Product Type:		B - Extent of Damage:		C - Surface Treatment		D - Asbestos Type		Material Ass (M.A) (A+B+C+D):	
Textured Coating						No Asbestos Detected		0	
1 = Normal Occupant Activity = (E)		E - Main type of activity		Total Priority Score (P.A.) = (1+2+3+4):		Total Risk Ass' Score (P.A. + M.A)		0	
2 = Disturbance = (F+G+H)/3		F - Location		G - Accessibility		H - Extent		Risk Coding	
3 = Exposure potential = (I+J+K)/3		I - Number of occupants		J - Frequency of use		K - Average time in use			
4 = Maintenance activity = (L+M)/2		L - Type of maintenance		M - Frequency of maintenance		Recommendation:		No recommendation required	
Further Information:									

## 4.0 Survey Findings – Survey Data Sheets

Surveyor		William Stevenson		Room/Area		010 - Second Floor Landing And Stairs			
Survey Date		19 December 2016		Level of Identification		Sampled			
				Sample No		0003			
Building		1 SINCLAIR PLACE		Item		Textured Coating To Plasterboard Ceiling			
Floor		2		Amount					
A - Product Type:		B - Extent of Damage:		C - Surface Treatment		D - Asbestos Type		Material Ass (M.A) (A+B+C+D):	
Textured Coating						No Asbestos Detected		0	
1 = Normal Occupant Activity = (E)		E - Main type of activity		Total Priority Score (P.A.) = (1+2+3+4):		Total Risk Ass' Score (P.A. + M.A)		0	
2 = Disturbance = (F+G+H)/3		F - Location		G - Accessibility		H - Extent		Risk Coding	
3 = Exposure potential = (I+J+K)/3		I - Number of occupants		J - Frequency of use		K - Average time in use			
4 = Maintenance activity = (L+M)/2		L - Type of maintenance		M - Frequency of maintenance		Recommendation:		No recommendation required	
Further Information:									

Surveyor		William Stevenson		Room/Area		014 - Third Floor Landing.			
Survey Date		19 December 2016		Level of Identification		Sampled			
				Sample No		0004			
Building		1 SINCLAIR PLACE		Item		Textured Coating To Plasterboard Ceiling			
Floor		3		Amount					
A - Product Type:		B - Extent of Damage:		C - Surface Treatment		D - Asbestos Type		Material Ass (M.A) (A+B+C+D):	
Textured Coating						No Asbestos Detected		0	
1 = Normal Occupant Activity = (E)		E - Main type of activity		Total Priority Score (P.A.) = (1+2+3+4):		Total Risk Ass' Score (P.A. + M.A)		0	
2 = Disturbance = (F+G+H)/3		F - Location		G - Accessibility		H - Extent		Risk Coding	
3 = Exposure potential = (I+J+K)/3		I - Number of occupants		J - Frequency of use		K - Average time in use			
4 = Maintenance activity = (L+M)/2		L - Type of maintenance		M - Frequency of maintenance		Recommendation:		No recommendation required	
Further Information:									

## 4.0 Survey Findings – Survey Data Sheets

Surveyor		William Stevenson		Room/Area		018 - Roof Void			
Survey Date		19 December 2016		Level of Identification		Sampled			
				Sample No		0005			
Building		1 SINCLAIR PLACE		Item		Roof Lining			
Floor		4		Amount					
A - Product Type:		B - Extent of Damage:		C - Surface Treatment		D - Asbestos Type		Material Ass (M.A) (A+B+C+D):	
Roofing Felt / Bitumen						No Asbestos Detected		0	
1 = Normal Occupant Activity = (E)		E - Main type of activity		Total Priority Score (P.A.) = (1+2+3+4):		Total Risk Ass' Score (P.A. + M.A)		0	
2 = Disturbance = (F+G+H)/3		F - Location		G - Accessibility		H - Extent		Risk Coding	
3 = Exposure potential = (I+J+K)/3		I - Number of occupants		J - Frequency of use		K - Average time in use			
4 = Maintenance activity = (L+M)/2		L - Type of maintenance		M - Frequency of maintenance		Recommendation:		No recommendation required	
Further Information:									



## 5.0 Survey Findings – Location Register

Building	Floor	Location	Asbestos, Non-Asbestos and Presumed Items				
			Limited or No Access Areas	Item	Material	Level of Identification	Asbestos Type
1 SINCLAIR PLACE	0	001 - Ground Floor Landing & Stairs.		Wall	Plaster		
1 SINCLAIR PLACE	0	001 - Ground Floor Landing & Stairs.		Walls	Plasterboard		
1 SINCLAIR PLACE	0	001 - Ground Floor Landing & Stairs.		Fixed Floor Tiles	Ceramic		
1 SINCLAIR PLACE	0	001 - Ground Floor Landing & Stairs.		Stairs	Concrete		
1 SINCLAIR PLACE	0	001 - Ground Floor Landing & Stairs.		Stair Nosing Strip	Rubber		
1 SINCLAIR PLACE	0	001 - Ground Floor Landing & Stairs.		Boxing To Ceiling, Housing Metal Pipework	Timber Products		
1 SINCLAIR PLACE	0	001 - Ground Floor Landing & Stairs.		Ceiling	Concrete		
1 SINCLAIR PLACE	0	001 - Ground Floor Landing And Stairs		Textured Coating To Plasterboard Ceiling	Textured Coating	S0001	NAD
1 SINCLAIR PLACE	0	002 - Riser Cupboard		Live Electrical Consumer Unit To Timber Wall Panels	Metal Products		
1 SINCLAIR PLACE	0	002 - Riser Cupboard		Floor	Concrete		
1 SINCLAIR PLACE	0	002 - Riser Cupboard		Walls	Brick		
1 SINCLAIR PLACE	0	002 - Riser Cupboard		Metal Pipework Insulation	Foam / Polystyrene		
1 SINCLAIR PLACE	0	003 - Riser Cupboard		Walls	Brick		
1 SINCLAIR PLACE	0	003 - Riser Cupboard		Door Head Panel	Timber Products		
1 SINCLAIR PLACE	0	003 - Riser Cupboard		Metal Pipework Insulation	Foam / Polystyrene		
1 SINCLAIR PLACE	0	003 - Riser Cupboard		Floor	Concrete		
1 SINCLAIR PLACE	0	003 - Riser Cupboard		Live Electrical Consumer Unit To Timber Wall Panels	Metal Products		
1 SINCLAIR PLACE	0	004 - Understairs Cupboard		Ceiling	Concrete		

## 5.0 Survey Findings – Location Register

Building	Floor	Location	Asbestos, Non-Asbestos and Presumed Items				
			Limited or No Access Areas	Item	Material	Level of Identification	Asbestos Type
1 SINCLAIR PLACE	0	004 - Understairs Cupboard		Walls	Brick		
1 SINCLAIR PLACE	0	004 - Understairs Cupboard		Floor	Concrete		
1 SINCLAIR PLACE	0	004 - Understairs Cupboard		Live Electrical Consumer Unit To Timber Wall Panels	Metal Products		
1 SINCLAIR PLACE	0	004 - Understairs Cupboard		Live Electrical Unit To Wall 2.	Metal Products		
1 SINCLAIR PLACE	0	005 - Riser Cupboard		Live Electrical Unit To Timber Wall Panels	Metal Products		
1 SINCLAIR PLACE	0	005 - Riser Cupboard		Metal Pipework Insulation	Foam / Polystyrene		
1 SINCLAIR PLACE	0	005 - Riser Cupboard		Door Frame Packers	Plasterboard		
1 SINCLAIR PLACE	0	005 - Riser Cupboard		Walls	Brick		
1 SINCLAIR PLACE	0	005 - Riser Cupboard		Floor	Concrete		
1 SINCLAIR PLACE	1	006 - First Floor Landing & Stairs.		Stairs	Concrete		
1 SINCLAIR PLACE	1	006 - First Floor Landing & Stairs.		Ceiling	Concrete		
1 SINCLAIR PLACE	1	006 - First Floor Landing & Stairs.		Stair Nosing Strip	Rubber		
1 SINCLAIR PLACE	1	006 - First Floor Landing & Stairs.		Floor Below Fixed Carpets	Concrete		
1 SINCLAIR PLACE	1	006 - First Floor Landing & Stairs.		Wall	Plasterboard		
1 SINCLAIR PLACE	1	006 - First Floor Landing & Stairs.		Walls	Plaster		
1 SINCLAIR PLACE	1	006 - First Floor Landing & Stairs.		Boxing To Ceiling, Housing Metal Pipework	Timber Products		
1 SINCLAIR PLACE	1	006 - First Floor Landing And Stairs		Textured Coating To Plasterboard Ceiling	Textured Coating	S0002	NAD
1 SINCLAIR PLACE	1	007 - Riser Cupboard		Door Frame Packers	Timber Products		

## 5.0 Survey Findings – Location Register

Building	Floor	Location	Asbestos, Non-Asbestos and Presumed Items				
			Limited or No Access Areas	Item	Material	Level of Identification	Asbestos Type
1 SINCLAIR PLACE	1	007 - Riser Cupboard		Walls	Brick		
1 SINCLAIR PLACE	1	007 - Riser Cupboard		Floor	Concrete		
1 SINCLAIR PLACE	1	007 - Riser Cupboard		Live Electrical Unit To Timber Wall Panels	Metal Products		
1 SINCLAIR PLACE	1	007 - Riser Cupboard		Metal Pipework Insulation	Foam / Polystyrene		
1 SINCLAIR PLACE	1	008 - Riser Cupboard		Metal Pipework Insulation	Foam / Polystyrene		
1 SINCLAIR PLACE	1	008 - Riser Cupboard		Door Head Panel	Plasterboard		
1 SINCLAIR PLACE	1	008 - Riser Cupboard		Live Electrical Unit To Timber Wall Panels	Metal Products		
1 SINCLAIR PLACE	1	008 - Riser Cupboard		Walls	Brick		
1 SINCLAIR PLACE	1	008 - Riser Cupboard		Floor	Concrete		
1 SINCLAIR PLACE	1	009 - Riser Cupboard		Walls	Brick		
1 SINCLAIR PLACE	1	009 - Riser Cupboard		Live Electrical Unit To Timber Wall Panels	Metal Products		
1 SINCLAIR PLACE	1	009 - Riser Cupboard		Metal Pipework Insulation	Foam / Polystyrene		
1 SINCLAIR PLACE	1	009 - Riser Cupboard		Door Frame Packers	Timber Products		
1 SINCLAIR PLACE	2	010 - Second Floor Landing & Stairs.		Floor Below Fixed Carpets	Concrete		
1 SINCLAIR PLACE	2	010 - Second Floor Landing & Stairs.		Ceiling	Concrete		
1 SINCLAIR PLACE	2	010 - Second Floor Landing & Stairs.		Walls	Plasterboard		
1 SINCLAIR PLACE	2	010 - Second Floor Landing & Stairs.		Wall	Plaster		
1 SINCLAIR PLACE	2	010 - Second Floor Landing & Stairs.		Boxing To Ceiling, Housing Metal Pipework	Timber Products		
1 SINCLAIR PLACE	2	010 - Second Floor Landing & Stairs.		Stair Nosing Strip	Rubber		
1 SINCLAIR PLACE	2	010 - Second Floor Landing & Stairs.		Stairs	Concrete		

## 5.0 Survey Findings – Location Register

Building	Floor	Location	Asbestos, Non-Asbestos and Presumed Items				
			Limited or No Access Areas	Item	Material	Level of Identification	Asbestos Type
1 SINCLAIR PLACE	2	010 - Second Floor Landing And Stairs		Textured Coating To Plasterboard Ceiling	Textured Coating	S0003	NAD
1 SINCLAIR PLACE	2	011 - Riser Cupboard		Walls	Brick		
1 SINCLAIR PLACE	2	011 - Riser Cupboard		Metal Pipework Insulation	Foam / Polystyrene		
1 SINCLAIR PLACE	2	011 - Riser Cupboard		Door Frame Packers	Timber Products		
1 SINCLAIR PLACE	2	011 - Riser Cupboard		Live Electrical Unit To Timber Wall Panels	Metal Products		
1 SINCLAIR PLACE	2	012 - Riser Cupboard		Walls	Brick		
1 SINCLAIR PLACE	2	012 - Riser Cupboard		Live Electrical Unit To Timber Wall Panels	Metal Products		
1 SINCLAIR PLACE	2	012 - Riser Cupboard		Metal Pipework Insulation	Foam / Polystyrene		
1 SINCLAIR PLACE	2	012 - Riser Cupboard		Door Head Panel	Plasterboard		
1 SINCLAIR PLACE	2	013 - Riser Cupboard		Metal Pipework Insulation	Foam / Polystyrene		
1 SINCLAIR PLACE	2	013 - Riser Cupboard		Door Frame Packers	Timber Products		
1 SINCLAIR PLACE	2	013 - Riser Cupboard		Live Electrical Unit To Timber Wall Panels	Metal Products		
1 SINCLAIR PLACE	2	013 - Riser Cupboard		Walls	Brick		
1 SINCLAIR PLACE	3	014 - Third Floor Landing.		Walls	Plaster		
1 SINCLAIR PLACE	3	014 - Third Floor Landing.		Wall	Plasterboard		
1 SINCLAIR PLACE	3	014 - Third Floor Landing.		Floor Below Fixed Carpets	Concrete		
1 SINCLAIR PLACE	3	014 - Third Floor Landing.		Stairs	Concrete		
1 SINCLAIR PLACE	3	014 - Third Floor Landing.		Stair Nosing Strip	Rubber		
1 SINCLAIR PLACE	3	014 - Third Floor Landing.		Boxing To Ceiling, Housing Metal Pipework	Timber Products		
1 SINCLAIR PLACE	3	014 - Third Floor Landing.		Loft Hatch	Timber Products		

## 5.0 Survey Findings – Location Register

Building	Floor	Location	Asbestos, Non-Asbestos and Presumed Items				
			Limited or No Access Areas	Item	Material	Level of Identification	Asbestos Type
1 SINCLAIR PLACE	3	014 - Third Floor Landing.		Ceiling	Plasterboard		
1 SINCLAIR PLACE	3	014 - Third Floor Landing.		Textured Coating To Plasterboard Ceiling	Textured Coating	S0004	NAD
1 SINCLAIR PLACE	3	015 - Riser Cupboard		Metal Pipework Insulation	Foam / Polystyrene		
1 SINCLAIR PLACE	3	015 - Riser Cupboard		Door Frame Packers	Timber Products		
1 SINCLAIR PLACE	3	015 - Riser Cupboard		Walls	Brick		
1 SINCLAIR PLACE	3	015 - Riser Cupboard		Ceiling	Concrete		
1 SINCLAIR PLACE	3	015 - Riser Cupboard		Live Electrical Unit To Timber Wall Panels	Metal Products		
1 SINCLAIR PLACE	3	016 - Riser Cupboard		Walls	Brick		
1 SINCLAIR PLACE	3	016 - Riser Cupboard		Live Electrical Unit To Timber Wall Panels	Metal Products		
1 SINCLAIR PLACE	3	016 - Riser Cupboard		Metal Pipework Insulation	Foam / Polystyrene		
1 SINCLAIR PLACE	3	016 - Riser Cupboard		Door Frame Packers	Timber Products		
1 SINCLAIR PLACE	3	016 - Riser Cupboard		Door Head Panel	Plasterboard		
1 SINCLAIR PLACE	3	016 - Riser Cupboard		Ceiling	Plasterboard		
1 SINCLAIR PLACE	3	017 - Riser Cupboard		Metal Pipework Insulation	Foam / Polystyrene		
1 SINCLAIR PLACE	3	017 - Riser Cupboard		Door Frame Packers	Timber Products		
1 SINCLAIR PLACE	3	017 - Riser Cupboard		Live Electrical Unit To Timber Wall Panels	Metal Products		
1 SINCLAIR PLACE	3	017 - Riser Cupboard		Walls	Brick		
1 SINCLAIR PLACE	3	017 - Riser Cupboard		Ceiling	Concrete		
1 SINCLAIR PLACE	4	018 - Roof Void		Walls	Brick		
1 SINCLAIR PLACE	4	018 - Roof Void		Floor	Plasterboard		
1 SINCLAIR PLACE	4	018 - Roof Void		Ceiling	Timber Products		
1 SINCLAIR PLACE	4	018 - Roof Void		Roof Lining	Roofing Felt / Bitumen	S0005	NAD
1 SINCLAIR PLACE	External	019 - External		Roof Tiles	Masonry		
1 SINCLAIR PLACE	External	019 - External		Roof Soffit	Plastic		
1 SINCLAIR PLACE	External	019 - External		Roof Fascia	Plastic		
1 SINCLAIR PLACE	External	019 - External		Window Sills	Concrete		

## 5.0 Survey Findings – Location Register

Building	Floor	Location	Asbestos, Non-Asbestos and Presumed Items				
			Limited or No Access Areas	Item	Material	Level of Identification	Asbestos Type
1 SINCLAIR PLACE	External	019 - External		Wall & Render	Masonry		
1 SINCLAIR PLACE	External	019 - External		Guttering	Plastic		
1 SINCLAIR PLACE	External	019 - External		Downpipes	Plastic		



0610



## 6.0 Survey Findings - Certificate & Schedule of Bulk Samples

**Client Contact:**

**Life Environmental Services Ltd**

CLAIRE DOW  
DUNEDIN CANMOREGROUP  
CLAIRE DOW  
8 NEW MART ROAD  
EDINBURGH

4 Duckett's Wharf  
South Street  
Bishop's Stortford  
Hertfordshire  
CM23 3AR

EH14 1RL

**Tel:**

**Tel:** 01279 503117

**Site:** 1 SINCLAIR PLACE  
EDINBURGH  
EH11 1AN

**Date Sampled/Received:** 19 December 2016. Sample(s) taken by William Stevenson.

Sample No.	Location/ Comments	Item Description	Material	Asbestos Result	Analyst (Analysis Date)	Comments (where applicable)
1	Ground Floor Landing And Stairs	Textured Coating To Plasterboard Ceiling	Textured Coating	NAD	Maria Stoughton (06/01/2017)	Not Applicable
2	First Floor Landing And Stairs	Textured Coating To Plasterboard Ceiling	Textured Coating	NAD	Maria Stoughton (06/01/2017)	Not Applicable
3	Second Floor Landing And Stairs	Textured Coating To Plasterboard Ceiling	Textured Coating	NAD	Maria Stoughton (06/01/2017)	Not Applicable
4	Third Floor Landing.	Textured Coating To Plasterboard Ceiling	Textured Coating	NAD	Maria Stoughton (06/01/2017)	Not Applicable
5	Roof Void	Roof Lining	Roofing Felt / Bitumen	NAD	Maria Stoughton (06/01/2017)	Not Applicable

**Analysts Name(s):** Maria Stoughton

**Signature(s):**

**TEST NOTES:**

1. Samples submitted for examination have been analysed to determine the presence of asbestos fibres using the methods documented in the HSG248 the Analyst Guide for Sampling Analysis and Clearance Procedures & in house procedures in section 11 of the Quality Manual.
2. Samples in this test report have been analysed at one of our accredited Laboratories (see addresses below). Please note, the material description is outside the scope of our UKAS accreditation.
3. This test report shall not be reproduced or copied without the written approval of Life Environmental Services Limited.
4. Opinion and interpretations are outside the scope of accreditation and are not included within this test report
5. Samples taken by Life Environmental Services Ltd are in accordance with the HSG 248 the Analyst Guide for Sampling Analysis and Clearance Procedures and HSG 264.
6. Life Environmental Services Ltd is not responsible for sampling errors where they have not taken the sample.

**Test Certificates Issued Under Head Office UKAS Accreditation No. 0610**

### Life Environmental Services

*The natural choice for environmental compliance and risk management solutions*

**Accredited Laboratories**

4 Duckett's Wharf  
South Street  
Bishop's Stortford  
Herts  
CM23 3AR

Analysed by

Caledonia House  
Thornliebank Industrial Estate  
Thornliebank  
Glasgow  
Scotland G46 8JT

Analysed by

Tel: 01279 503117

Tel: 0141 270 8070

## Appendix 1 – Definitions & Recommended Guidance

---

### Level of Identification

**Sample (S)** A physical sample was taken on site by the Surveyor and analysed by the laboratory.

**Cross reference (X)** No sample was taken but the material is visually similar to a sample that has been analysed from the survey. This is a form of Strong Presumption as defined in HSG264.

**Strongly Presumed (SP)** No sample was taken but due to the appearance of the material and with the surveyor's knowledge and experience the material has been identified as containing asbestos.

**Presumed (P)** No sample was taken and therefore due to this lack of information the material or item must be presumed to contain asbestos. This will often be because the item could not be sampled due to excessive height (such as soffits) or an item could not be inspected (or sampled) as this may have presented a risk to the Surveyor (e.g. opening up live plant and electrics).

No access areas are also treated as a presumption.

**Inspected Area (IA)** this illustrates that a particular area within a room has been inspected and no suspect materials were identified. It is an opportunity for the surveyor to photograph and record that a particular element has been inspected without the need to sample. This will usually be during a refurbishment survey.

### Non-suspect items

The surveyor will record non-suspect items as part of the survey. This will include non-asbestos materials which can be confused as containing asbestos by those who have less experience of ACMs. This will include non-asbestos boards (e.g. Supalux and Vermiculite), modern vinyl products, modern bitumen products, etc. The surveyor may record other non-asbestos items as determined during the course of the survey.

Non-asbestos boards will also be sampled periodically throughout the building to confirm they are non-asbestos. In rooms where there are no non-asbestos items and no suspect items to record the surveyor will record 'All Areas/Items – No Suspect Materials Seen' this illustrates that the surveyor has inspected all areas of the room as far as is reasonably practicable in accordance with the survey scope and has deemed the room asbestos free.

Non-suspect items are recorded within the Location Register in Section 5.

### Floor

All ACMs are detailed by location number, with the relevant floor given by numerical value. However, in instances where a room or location is present over more than one floor (e.g. Staircases and Lift Shafts) the floor may be detailed as 'Multiple'. Hence when reviewing the Asbestos Register to gain an overview of an entire floor, it is necessary to consult two sections of the register, firstly the relevant floor, secondly any 'Multiple' locations that may be present.

### Recommendations

The various recommendations given within this report are explained below:-

#### **Manage & Re-inspect**

Where asbestos is left in situ there is a duty to formulate and implement a Management Plan to help prevent accidental damage and exposure.

The basic requirements of this policy are (from HSG 264):

- Keep and maintain an up-to-date record of the location, condition, maintenance and removal of all asbestos-containing materials
- Maintain it in a good state of repair and regularly monitor the condition
- Inform anyone who will potentially come into contact with or disturb the material as to its location and condition
- Have arrangements and procedures in place, so that work which may disturb the materials complies with the Control of Asbestos Regulations 2012



## Appendix 1 – Definitions & Recommended Guidance

---

- Review the plan at regular intervals

### Label

A decision should be taken as to whether to label ACMs. The decision will depend on the confidence in the administration of the asbestos management system and whether communication with workers and contractors coming to work on site can be effective.

Labelling ACMs should not be solely relied on as a control measure; however it is an effective method of preventing exposure to building occupants (and, in particular, maintenance workers). If, for any reason, management procedures fail, it may act as an effective last barrier to uncontrolled damage to the ACM.

It may not always be prudent or practical to label all installations of asbestos; for example high level items such as roof sheets, flue cowls and soffits or items such as gaskets to pipe flanges, textured coating and floor tiles.

### Encapsulate

When this recommendation has been given, the ACM is raw and requires encapsulating with a suitable sealant or the existing sealant or covering has deteriorated and the installation requires either a complete or partial re-encapsulation. We recommend that sealing or painting of insulating board, insulation or spray coatings should be undertaken by a licensed contractor and is likely to be subject to a 14 day notification to the HSE, (as per the Control of Asbestos Regulations 2012).

### Repair

The material has sustained damage to some area or areas and requires attention to make good the material so that it can be managed safely. This will often involve some element of decontamination if debris is associated with the damage.

### Remove

If an item is recommended for removal it has either sustained damage and is posing an increased risk in its current condition; or due to its location it is considered high risk as it could easily be disturbed in the future. Materials recommended for removal will be given one of the following recommendations:-

**Removal by Licensed Contractor.** This will include removal of AIB, Insulation, and Spray Coatings and is likely to be subject to a 14 day notification to the HSE, (as per the Control of Asbestos Regulations 2012).

**Removal by Approved Contractor.** This will include removal of lower risk materials such as Asbestos Cement, Bitumen Products, Reinforced Composites, and Floor Tiles etc. Some such works may be considered Notifiable Non-Licensed Works.

The Control of Asbestos Regulations 2012 does not necessarily require such removal works to be undertaken by a licensed contractor. However it is good practice, and we would strongly recommended that all removal works are undertaken by a licensed contractor.

### Restrict Access

Materials have been identified that are in a damaged condition often with associated debris that can be easily disturbed. As such access to the area should be prevented to all persons until such a time when the area has been deemed safe for reoccupation. This will usually be once removal works have been completed.

### No Access – Inspection Required

Access to the given location was either not possible at all or only limited access was possible. In both instances there is the potential for unidentified asbestos being present and as such the area must be treated as containing asbestos until full access is possible.

Arrangements should be made at the earliest opportunity to revisit locations where access was not possible or access was limited in order that such areas can be inspected fully.

## Appendix 1 – Definitions & Recommended Guidance

---

Items and materials that are presumed to contain asbestos will also be given the recommendation of 'No Access – Inspection required'. In these instances the item or material should be treated as containing asbestos until arrangements can be made to access such items or materials in order to carry out an inspection or sample to confirm or otherwise the presence of asbestos.

### **No Recommendation Required**

Asbestos has not been identified and as such no further action is required.

### **Recommended Guidance**

To comply with and ensure that the requirements of section 2 & 3 of the Health and Safety at Work Act (as amended) 1974, the Management of Health and Safety at Work Regulations 1999, the Control of Asbestos Regulations 2012 and the Control of Substances Hazardous to Health 2002 are met, the following recommendations should be implemented:

Undertake suitable and sufficient Risk Assessments of identified ACMs against normal occupation and maintenance operations, in compliance with Regulations 3 of the Management of Health & Safety at Work Regulations 1999 and Regulation 6 of the Control of Asbestos Regulations 2012.

The findings of the survey be brought to the attention of those persons who are likely to come in contact with asbestos, in compliance with Section 2 and 3 of the Health and Safety at Work Act (as amended) 1974 and Regulation 9 of the Control of Asbestos Regulations 2012.

Implement an Asbestos Management Policy, Plan and review process in compliance Regulation 4 of the Control of Asbestos Regulations 2012.

During the course of the survey it may not have been possible to access all areas of the site. Details of areas requiring further access is identified within the Data Sheets and Executive Summary of this report. In accordance with HSG 264, asbestos is presumed to be present within these areas and should be treated accordingly until further inspection and analysis of building fabric and services proves otherwise.

It is recommended that air monitoring is carried out within any areas where ACMs have been identified in order to assess airborne fibre levels within adjacent occupied areas in relation to the clearance indicator, as documented by HSG 248 The Analyst Guide.

Where asbestos debris or asbestos in poor condition has been found it is recommended that access is restricted to these areas in accordance with Regulation 11 of the Control of Asbestos Regulations 2012 and that air monitoring is carried out within adjacent areas in order to assess airborne fibre levels.

All identified asbestos to be appropriately identified and subject to Risk Assessment, management, and re-inspection.

Site specific recommendations in respect to the location and condition of asbestos materials identified during the course of this inspection are detailed in the Survey Data Sheets and Asbestos register. In considering the management of asbestos materials identified to date, these recommendations should be referred to and complied with.

It is recommended that work on, or removal of, both licensed and non licensed ACMs is undertaken by a licensed asbestos removal contractor so that the Duty Holder / Client can have confidence that the contractor has provided the correct level of training and has the experience and knowledge necessary to deal with these products safely.

It is a requirement of CAR 2012 that further intrusive investigations and sampling be carried out where any refurbishment, maintenance, or similar activity is planned that may expose asbestos materials. This should be a refurbishment/demolition survey as documented by HSG 264.

The findings of this report should not be solely relied upon in obtaining costs for proposed asbestos abatement work. Any proposed abatement/removal of the asbestos should be undertaken against a detailed specification.

## Appendix 2 – Material & Priority Assessment Algorithms

Where ACMs have been identified or presumed to be present a **Material Assessment Algorithm** has been calculated as detailed in HSG 264 and reproduced in line with the table overleaf.

The Material Assessment is an assessment of the condition of the ACM, or the presumed ACM, and the likelihood of it releasing fibres in the event of it being disturbed in some way. This Material Assessment will give a good initial guide to the priority for management as it will identify the materials which will most readily release airborne fibres if disturbed. However, there are other factors to take into account when prioritising action. These are considered in the Priority Assessment which is described later.

For each of the four variables given by the table a score is allocated. The four scores are added together to give a Material Assessment score of between 2 and 12.

### HIGH RISK 10-12

Materials with scores of 10 or more should be regarded as high risk with a significant potential to release fibres if disturbed;

### MEDIUM RISK 7- 9

Those materials with a score between 7 and 9 are regarded as medium risk to release fibres.

### LOW RISK 5-6

Materials with a score between 5 and 6 are low risk to release fibres.

### VERY LOW RISK 4 or less

Scores of 4 or less are very low risk.

Section	Sample Variable	Score	Examples of Score
A	Product type (or debris from product).	1	Asbestos reinforced composites (plastics, resins, mastics, roofing felts, vinyl floor tiles, semi rigid paint or decorative finishes, asbestos cement, etc).
		2	Asbestos insulating board, mill boards, other low-density insulation boards, asbestos textiles, gaskets, ropes and woven textiles, asbestos paper and felt.
		3	Thermal insulation (e.g.: pipe and boiler lagging), sprayed asbestos, loose asbestos, asbestos mattresses and packing.
B	Extent of damage/deterioration.	0	Good condition: no visible damage.
		1	Low damage: a few scratches or surface marks; broken edges on boards, tiles, etc.
		2	Medium damage: significant breakage of materials or several small areas where material has been damaged revealing loose asbestos fibres.
		3	High damage or delamination of materials, sprays and thermal insulation. Visible asbestos debris.
C	Surface Treatment	0	Composite materials containing asbestos: reinforced plastics, resins, vinyl tiles.
		1	Enclosed sprays and lagging, AIB (with exposed face painted or encapsulated), unsealed cement sheets, etc.
		2	Unsealed AIB, or encapsulated lagging and sprays.
		3	Unsealed lagging and sprays.
D	Asbestos type	1	Chrysotile.
		2	Amphibole asbestos excluding Crocidolite.
		3	Crocidolite.
<b>Material Assessment Score = A + B + C + D</b>			

## Appendix 2 – Material & Priority Assessment Algorithms

---

The Material Assessment identifies the high risk materials, that is, those which will most readily release airborne fibres if disturbed. It does not automatically follow that those materials assigned the highest score in the Material Assessment will be the materials that should be given priority for remedial action. Management priority must be determined by carrying out a Risk Assessment which will also take into account the likely maintenance activity; occupant activity; likelihood of disturbance; and human exposure potential.

The **Priority Assessment Algorithm** looks at the likelihood of someone disturbing the ACM. **Please note Priority Assessments have been undertaken as part of this survey.**

A legal requirement to carry out a Risk Assessment for all work activities exists under the Management of Health and Safety at Work Regulations 1999. The requirement to assess the risk posed by asbestos is further enforced by the Control of Asbestos Regulations 2012. These regulations require that asbestos present in the workplace must not present a hazard to health

The risks from asbestos should be assessed and managed for all identified or presumed ACMs. The Risk Assessment or priority rating will establish the likelihood of people being exposed to the hazard and identify the measures to be taken that will either eliminate the hazard or adequately control it.

The Priority Assessment Score is calculated on the average scores for each of the four human exposure factors given by the table on the following page.

**It is the responsibility of the Duty Holder to complete the Priority Risk Assessment, and ensure it remains up to date and accurate.**

### Risk Assessment

The **Risk Assessment Priority Algorithm** is calculated by adding the **Material Assessment Score** obtained during the survey to the **Priority Assessment Score**.

#### **HIGH RISK - 18 POINTS OR MORE**

The potential hazard arising from this category warrants urgent action. Immediate plans should be made for the removal/containment of the ACM. If delay in remedial action is likely to occur the affected area should initially be sealed-off and appropriate warning signs posted.

#### **MEDIUM RISK - 14-17 POINTS**

This category indicates that deterioration in any of the contributory factors may result in fibre release. Therefore all asbestos should be contained/sealed/encapsulated.

#### **LOW RISK - 9-13 Points**

This category indicates the need for regular monitoring. Although the current risk of fibre release is low, this material may suffer deterioration through age/local accidental damage.

#### **VERY LOW RISK 8 or less**

Similarly this category requires regular monitoring. Although the current risk of fibre release is low, this material may suffer deterioration through age/local accidental damage

## Appendix 2 – Material & Priority Assessment Algorithms

Section	Factor	Score	Examples of Score
<b>Normal Occupant Activity</b> Score = E			
E	Main Type of Activity	0	Rare Disturbance activity (e.g. Store Room)
		1	Low Disturbance Activity (e.g. Office)
		2	Periodic Disturbance (May contact ACMs)
		3	High Level of disturbance (e.g. panel on door)
<b>Likelihood of Disturbance</b> Score = Average of F + G + H			
F	Location	0	Outdoors
		1	Large Rooms or well ventilated Areas
		2	Rooms up to 100sqm
		3	Confined Spaces
G	Accessibility	0	Usually Inaccessible or unlikely to be disturbed
		1	Occasional Disturbance
		2	Easily Disturbed
		3	Routinely Disturbed
H	Extent	0	Very Small Amounts
		1	<10sqm or <10lm
		2	>10sqm to <50sqm or >10lm to <50lm
		3	<50sqm or >50lm
<b>Human Exposure Potential</b> Score = Average of I + J + K			
I	No of Occupants	0	None
		1	1-3
		2	4-10
		3	>10
J	Frequency of Use	0	Infrequent
		1	Monthly
		2	Weekly
		3	Daily
K	Average Time in Use	0	<1 Hour
		1	>1 hour and <3 hours
		2	>3 hours to <6 hours
		3	>6 Hours
<b>Maintenance Activity</b> Score = Average of L + M			
L	Type of Activity	0	Minor disturbance e.g. possible contact
		1	Low disturbance e.g. removing light bulb
		2	Medium Disturbance
		3	High levels of disturbance
M	Frequency of Maintenance	0	ACM unlikely to be disturbed
		1	1 per Year
		2	>1 per year
		3	>1 per Month

## Appendix 3 – Survey Drawings

---



Life Environmental Services Ltd.  
 4 Ducketts Wharf  
 South Street  
 Bishop's Stortford CM23 3AR  
 Telephone: 0844 335 1281  
 Email: enquiries@lifeenvironmental.com  
 www.lifeenvironmental.co.uk  
 Registered in England No. 3053057

**Management Survey Plan**  
 Dunedin Canmore Group  
 1 Sinclair Place  
 Edinburgh  
 EH11 1AN  
 Job No.: s-61210

Ground Floor

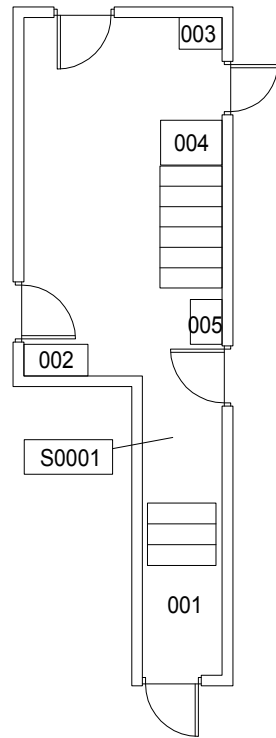

1st Floor

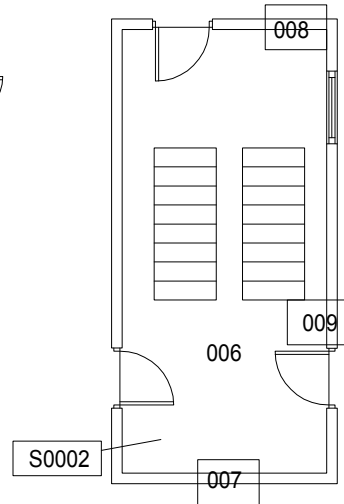

2nd Floor

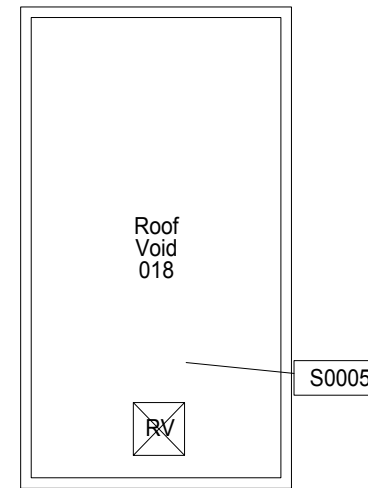
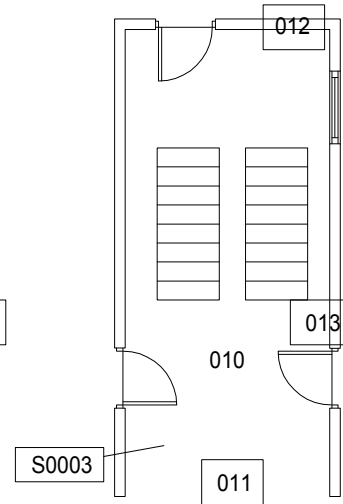

3rd Floor

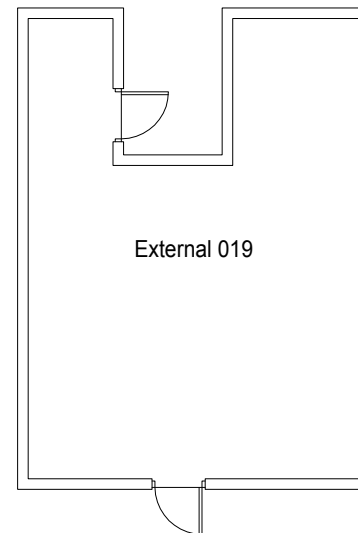
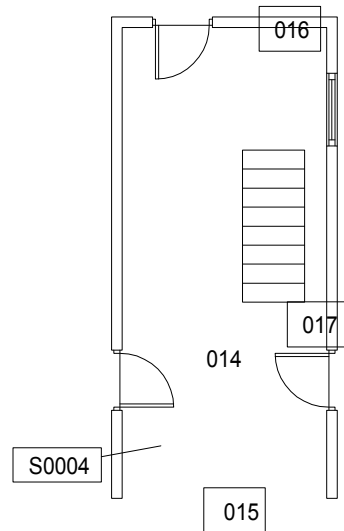

**Key**

- 001 - Location Number
- - Floor Void Access
- Asbestos Present (Please refer to register)
- No Access
- Limited Access
- Outside Scope of Survey
- S0001 - Asbestos Removed
- S0001 - Positive Sample
- X0001 - Cross Referenced Sample
- SP - Strongly Presumed Asbestos
- P - Presumed Asbestos
- S0001 - Negative Sample
- X0001 - Negative Cross Referenced Sample

Drawn By:	LM
Date:	09/01/17
Surveyor Initials:	WS
Survey Date:	19/12/16
Revision No.:	2.4a Oct 2016
Page:	1 of 1